

Beretta 92G

Caliber 9mm Parabellum

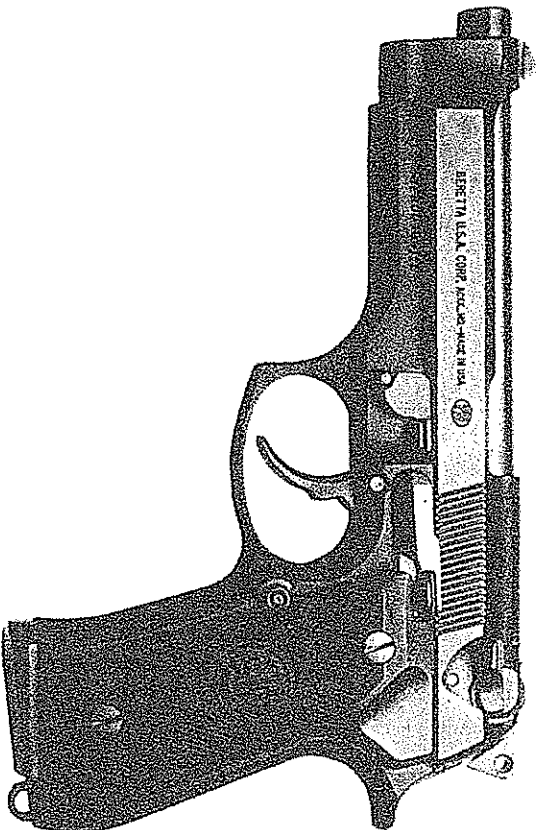

Instructions for operation

Caution: Read this manual carefully before handling and loading the pistol.

WARNING: This pistol is equipped with a HAMMER-DECOCKING LEVER ONLY. IT DOES NOT HAVE AN EXTERNAL MANUAL SAFETY LEVER. To safeguard against accidental discharge, ALWAYS, keep the hammer decocked and your fingers off the trigger. DO NOT leave the pistol (chamber or magazine) loaded or unattended where accessible by an unauthorized person or a child under the age of 18. Carefully read this instruction manual.

BASIC SAFETY RULES

1. NEVER POINT A FIREARM AT SOMETHING THAT IS NOT SAFE TO SHOOT.

Never let the muzzle

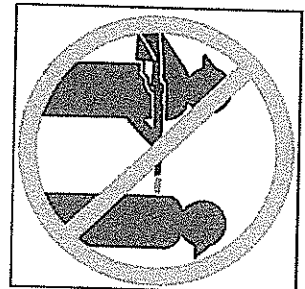

of a firearm point at any part of your body or at another person. This is especially important when loading or unloading the firearm. When you are shooting at a target, know what is behind it. Some bullets can travel over a mile. If you miss your target or if the bullet penetrates the target, it is your responsibility to ensure that the shot does not cause unintended injury or damage.

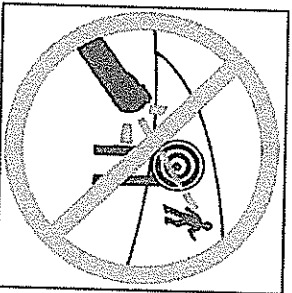

2. ALWAYS TREAT A FIREARM AS IF IT WERE LOADED.

Never assume that a firearm is unloaded. The only certain way to ensure that a firearm is empty is to open the chamber and visually examine the inside to see if a round is present. Removing the magazine will not guarantee that a pistol is unloaded or cannot fire. Shotguns and rifles can be checked by cycling or removing all rounds and by then opening the chamber so that a visual inspection of the chamber for any remaining rounds can be made.

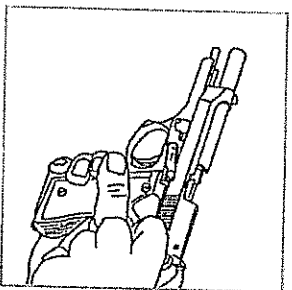

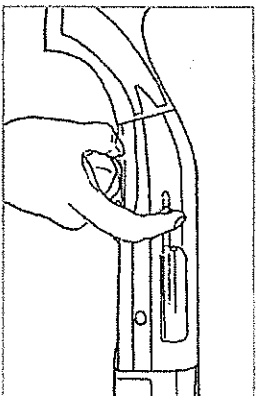
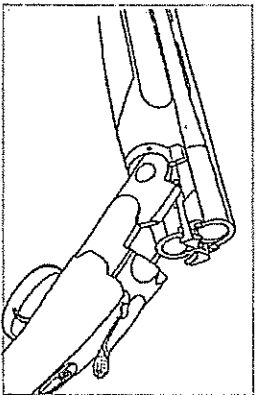

3. **STORE YOUR FIREARM SO THAT CHILDREN CANNOT GAIN ACCESS TO IT**
It is your responsibility to insure that children under the age of 18 or other unauthorized persons do not gain access to your firearm. To reduce the risk of accidents involving children, unload your firearm, lock it and store the ammunition in a separate locked location. Please note that devices intended to prevent accidents—for example, cable locks, chamber plugs, etc.—may not prevent use or misuse of your firearm by a determined person. Steel gun safes may be more appropriate to reduce the likelihood of intentional misuse of a firearm by an unauthorized child or person.

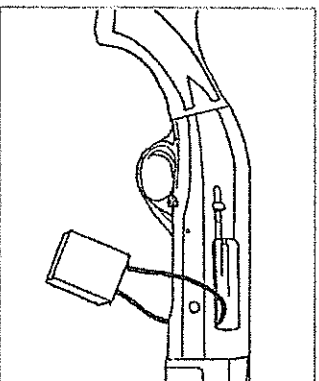
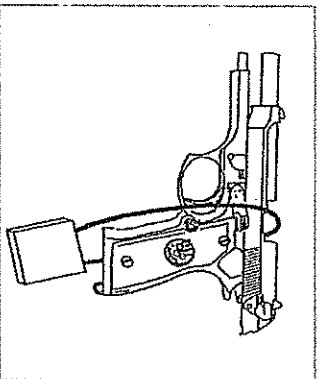

4. **NEVER SHOOT AT WATER OR AT A HARD SURFACE.**

Shooting at the surface of water or at a rock or other hard surface increases the chance of ricochets or fragmentation of the bullet or shot, which can result in the projectile striking an unintended or peripheral target.

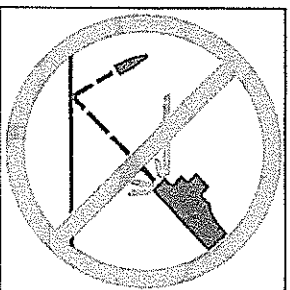

5. KNOW THE SAFETY FEATURES OF THE FIREARM YOU ARE USING, BUT REMEMBER: SAFETY DEVICES ARE NOT A SUBSTITUTE FOR SAFE HANDLING PROCEDURES. Never rely solely on a safety device to prevent an accident. It is imperative that you know and use the safety features of the particular firearm you are handling, but accidents can best be prevented by following the safe handling procedures described in these safety rules and elsewhere in the product manual. To further familiarize yourself with the proper use of this or other firearms, take a Firearms Safety Course taught by an expert in firearms use and safety procedures.

6. PROPERLY MAINTAIN YOUR FIREARM.

Store and carry your firearm so that dirt or lint does not accumulate in the working parts. Clean and oil your firearm, following the instructions provided in this manual, after each use to prevent corrosion, damage to the barrel or accumulation of impurities which can prevent use of the gun in an emergency. Always check the barrel prior to loading to ensure that it is clean and free from obstructions. Firing against an obstruction can rupture the barrel and injure yourself or others nearby. In case you hear an unusual noise when shooting, stop firing immediately, engage the manual safety and unload the firearm. Make sure the chamber is free from any obstruction or possible bullet blocked inside the barrel due to defective or improper ammunition.

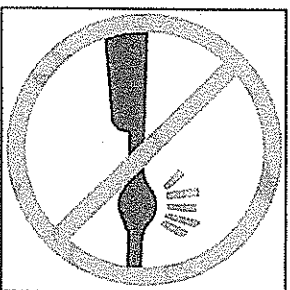

7. USE PROPER AMMUNITION.

Only use factory-loaded, new ammunition manufactured to industry specifications: CIP (Europe and elsewhere), SAAMI (U.S.A.). Be certain that each round you use is in the proper caliber or gauge and type for the particular firearm. The caliber or gauge of the firearm is clearly marked on the barrels of shotguns and on the slide or barrel of pistols. The use of reloaded or remanufactured ammunition can increase the likelihood of excessive cartridge pressures, casehead ruptures or other defects in the ammunition which can cause damage to your firearm and injury to yourself or others nearby.

8. ALWAYS WEAR PROTECTIVE GLASSES AND EARPLUGS WHEN SHOOTING.

The chance that gas, gunpowder or metal fragments will blow back and injure a shooter who is firing a gun is rare, but the injury that can be sustained in such circumstances is severe, including the possible loss of eyesight. A shooter must always wear impact resistant shooting glasses when firing any firearm. Earplugs help reduce the chance of hearing damage from shooting.

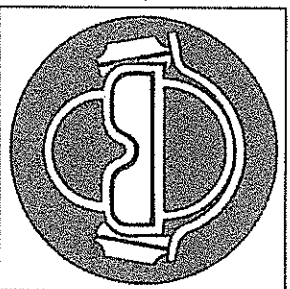

9. NEVER CLIMB A TREE, FENCE OR OBSTRUCTION WITH A LOADED FIREARM. Open and empty the chamber of your firearm before climbing or descending a tree or before climbing a fence or jumping over a ditch or obstruction. Never pull or push a loaded firearm toward yourself or another person.

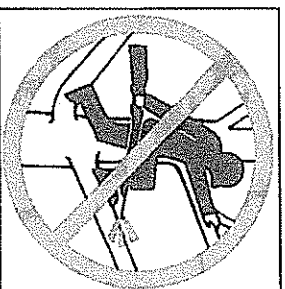

10. AVOID ALCOHOLIC BEVERAGES OR JUDGMENT OR REFLEX IMPAIRING MEDICATION WHEN SHOOTING. Do not drink and shoot. If you take medication that can impair motor reactions or judgment, do not handle a firearm while you are under the influence or the medication.

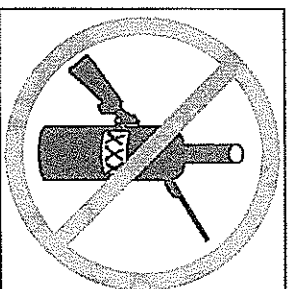

11. NEVER TRANSPORT A LOADED FIREARM. Unload a firearm before putting it in a vehicle. Hunters and target shooters should load their firearm only at their destination. If you carry a firearm for self-protection, leaving the chamber unloaded can reduce the chance of accidental discharge.

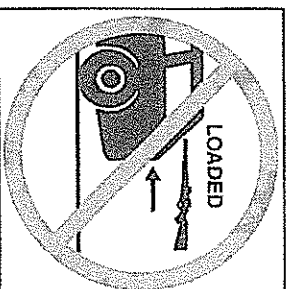

12. LEAD WARNING. Discharging firearms in poorly ventilated areas, cleaning firearms or handling ammunition may result in exposure to lead and other substances known to cause birth defects, reproductive harm, and other serious physical injury. Have adequate ventilation at all times. Wash hands thoroughly after exposure.

TABLE OF CONTENTS

	Page
Basic Safety	1
Introduction	8
Description	8
A. Locking System	8
B. Single/Double Action	8
C. Magazine	8
D. Safety Features	8
1. Ambidextrous Hammer-Decocking Lever	8
2. Firing Pin Unit	8
3. Hammer Drop Catch (half-cocked)	8
4. Automatic Firing Pin Catch	9
5. Chamber Loaded Indicator	9
6. Slide Overtravel Stop	9
E. Field Stripping Simplicity	9
F. Functional and Mechanical Features	9
1. Slide Catch	9
2. Ambidextrous Hammer-Decocking	9
3. Special Sights	9
4. V-Grooved Frame Serration	9
5. Reversible Magazine Release Button	9
6. Checkered Grips	10
7. Combat Trigger Guard	10
General Functional Principle	10
Loading and Firing	10
Loading the Magazine	11

Table of Contents (cont'd)

	Page
Loading the Pistol	11
Loading to Maximum Pistol Capacity	12
Direct Chamber Loading	12
Firing	13
Firing After Manual Hammer Cocking	13
Unloading the Pistol	13
Unloading the Magazine	14
Maintenance	14
Field Stripping	14
Recommended Safety Feature Inspection	16
What to Use for Cleaning	16
Barrel Cleaning and Lubrication	16
Slide Cleaning and Lubrication	17
Recoil Spring and Guide Lubrication	17
Frame Cleaning and Lubrication	17
Magazine Cleaning and Cartridge Rotation	18
After Field Stripping Assembly	18
Ammunition	18
Dry Firing/"DUMMY" Rounds	19
Trouble Shooting, Cause and Remedies	20
Technical Specifications	20
Photo Illustrations	22
Exploded Drawing	24
Parts List	25
Parts and Service	26
Limited Warranty	26

INTRODUCTION

The Beretta 92G semiautomatic pistol is primarily designed as a personal defense sidearm for military and police use. Due to its highly advanced safety features and its excellent performance in competitive tastings, it has become the choice of military and police forces throughout the world.

DESCRIPTION

A. LOCKING SYSTEM: The unique barrel-mounted falling locking block and short barrel recoil stroke ensures long service life and targeting accuracy.

B. SINGLE/DOUBLE ACTION: This system retains the advantages of the revolver combined with that of conventional single action semiautomatic pistols. After chambering the first round by pulling the slide to the rear and releasing it, the pistol is ready for discharge by the light single action trigger pull. Through appropriate hammer decocking, the shooter can fire the chambered round from the hammer's at rest position by the more pronounced double action pull. This also insures the safety advantage of trigger pull repeat in case of misfire.

C. MAGAZINE: The staggered, strongly constructed, case-hardened, steel magazine with hard coated aluminum follower and quick removable floor plate, for ease of cleaning, almost doubles the firepower of the traditional single line magazine of same length to a 15-round capacity.

D. SAFETY FEATURES:

1. AMBIDEXTROUS HAMMER-DECOCKING LEVER: Downward thumb pressure rotation of the hammer-decocking lever safely interrupts and shields the firing pin unit from hammer strike, as the hammer is automatically released to fall from its fully-cocked to fully-lowered position, at the last stage of the lever descent. When removing the thumb from the lever it will automatically by energetic spring action return to its deactivated position pronounced by the wings pointing straight forward and vivid Red Warning Dots.

Remember: Always lower the hammer by the hammer-decocking lever.

2. FIRING PIN UNIT: The two piece firing pin unit functioning on the inertia principle is designed to insure positive discharge combined with ultimate accidental discharge prevention during slide reciprocating chamber loading, hammer decocking and/or inadvertent handling impact. Since the firing pin unit is shorter than the slide breech, the pistol can be carried with the chamber loaded and the hammer fully-lowered to rest against the breech. During hammer lowering by the hammer-decocking lever, the rear section of the firing pin is rotated out of hammer reach.

3. HAMMER DROP CATCH (half-cocked): Since this is a double action pistol without thumb safety, the device acts as emergency, accidental discharge preventive hammer drop catch. To counteract the remote chance of accidental discharge due to UNTRIGGERED sear/hammer notch disengagement from the fully-cocked position, failure of hammer cocking during slide recoil

reciprocation, inadvertent hammer fanning or thumb slipping off the hammer spur during cocking, the hammer is caught half-cocked by the sear before striking the firing pin unit. To protect this device against hammer spur impact damage DO NOT carry the hammer half-cocked but fully-lowered.

4. **AUTOMATIC FIRING PIN CATCH:** This device positively prevents accidental discharge of a chambered round by firing pin inertia should the pistol inadvertently be dropped onto the ground. Also, it prevents firing pin inertia (primer ding mark) discharge of a cartridge during manual slide manipulation chamber loading as well as automatic slide recoil reciprocating chambering during shooting while the shooter keeps the trigger retracted. This device only becomes disconnected to permit pistol discharge at the last stage of either the double or single action trigger pull. Further, by being clearly visible in front of the rear sight the shooter can at a glance verify if the catch is engaged DOWN or disengaged UP.

5. **CHAMBER LOADED INDICATOR:** When a cartridge is chambered, the extractor head protrudes outside the slide breach, exposing a red warning signal. In the dark, the protrusion can be felt by touch. This makes it unnecessary to pull back the slide to verify if the chamber is loaded.

6. **SLIDE OVERTRAVEL STOP:** The head flange of the hammer pin enters a matching travel groove cut into the underside of the left slide rail to stop the slide breech in case of recoil overtravel.

E. **FIELD STRIPPING SIMPLICITY:** Advanced disassembly latch design allows for quick and simple field stripping, even by a fatigued user under hostile conditions.

F. **FUNCTIONAL AND MECHANICAL FEATURES:**

1. **SLIDE CATCH:** As the last round is fired, the recoil reciprocating slide is automatically locked open by the slide catch, clearly signaling the magazine is empty. For slide closing by right shooting hand, push the catch down by the thumb. When using left shooting hand push the catch down by the index finger.

2. **AMBIEXTROUS HAMMER-DECOCKING:** Allows for quick and easy right- or-left-handed operation.

3. **SPECIAL SIGHTS:** Both the fixed front and drift adjustable rear sights are designed for swift target acquisition. To aid sighting under low light conditions, the sights are equipped with white inlays.

4. **V-GROOVED FRAME SERRATION:** The grip front and back straps are longitudinally serrated to secure a firm hold even with wet hands or under conditions of rapid, unaimed fire.

5. **REVERSIBLE MAGAZINE RELEASE BUTTON:** The thumb release button is factory installed for right-handed operation, conveniently located behind the trigger guard strap for quick combat release. If shooting left-handed, the button can be reached and depressed with ease by the left-hand index or second finger.

A left-handed shooter may prefer the device installed with the button on the right for convenient operation. After removing both grip panels the device can simply be pushed out of its seat by applying finger pressure from the buttonless side for reverse installation. Armorer assistance recommended.

6. **CHECKERED GRIPS:** The high impact resistant plastic grips (walnut grips on request) have thumb relief for ease of safety-decocking lever reach and full grasp area checkered to ensure better hold with a touch of elegance.

7. **COMBAT TRIGGER GUARD:** The trigger guard front strap is crosswise V-groove serrated to insure firm rest of the index finger when shooting with two hand hold.

GENERAL FUNCTIONAL PRINCIPLE:

All Beretta pistols of the 92 Series are semi-automatic, functioning on the delayed blowback, short barrel recoil stroke principle, utilizing a unique falling locking block system.

Considering the pistol magazine and chamber loaded, the hammer decocked to its fully-lowered position, the pistol is ready for discharge by the double-action trigger pull mode.

Upon trigger pull discharge of the chambered round the powder gas pressure recoils the locked together barrel locking block/slide unit, compressing the recoil spring. After a short run the locking block, via its plunger, smoothly disengages the locking system. As the barrel recoil stops, the disconnected slide completes its recoil stroke, during which the hammer is rotated into cocking motion, the spent cartridge case extracted and ejected and the next cartridge in the magazine lifted up in front of the slide breech ready for chambering. At the moment the slide recoil is halted, the compressed recoil spring pushes the slide forward chambering the next cartridge. As the slide leaves the hammer the sear retains it fully-cocked, ready for single action trigger pull mode. Upon chambering, the slide breech pushes the barrel unit forward, and as the locking block slides up the frame's lifting support cam, the slide closing stroke is completed. The shooter must allow the trigger to go forward and re-engage to fire the next round.

After the last round is fired and the slide breech recoils past the magazine well, the spring activated magazine follower lifts the slide catch, which upon the slide's closing stroke locks the slide open, signalling the pistol is empty.

LOADING AND FIRING:

CAUTION: Always keep finger off the trigger until ready to fire.

Make sure the chamber is not already loaded by inspecting the extractor's chamber-loaded indicator (Fig. 4-D3).

LOADING THE MAGAZINE:

To load the magazine, remove it from the pistol by depressing the magazine release button (Fig. 7).

Hold the magazine in the left hand. With your right hand place a cartridge on the follower in front of the lips, press down and slide the cartridge completely back under the lips (Fig. 8). For ease of continued loading place the head of the next cartridge to be loaded on the front of the case, not bullet, of the cartridge in the magazine as you press down for inserting. Holes on the back of the magazine marked 5-10-15 allow for quick counting.

NOTE: When brass of ONE cartridge only can be seen entering the lower hole the magazine is loaded to its full 15 rounds capacity. DO NOT TRY TO FORCE AN EXTRA ROUND INTO THE MAGAZINE. The felt additional space is needed to insure perfect functioning.

LOADING THE PISTOL:

CAUTION: Always keep finger off the trigger until ready to fire. Make sure the muzzle is pointing in a safe direction.

NOTE: The hammer will be retained fully-cocked after a completed slide reciprocation. After a short slide reciprocation the hammer will be retained "half-cocked" by the hammer drop catch feature. Therefore, as a safety precaution, ALWAYS, unless ready to fire, decock the hammer by the aid of the hammer-decocking lever.

- Push the loaded magazine into the pistol grip well to solid stop in one continuous, firm hand stroke to insure positive catch engagement, verified by a sharp click. (Make sure not to slam the magazine as it may result in feeding malfunctioning, magazine and/or ammunition damage.)
- Grasping the slide serrations with thumb and index finger, fully retract and without hesitation release the slide for energetic closing stroke, insuring chamber loading and slide lock-up.

CAUTION: The pistol is now CHAMBER LOADED, COCKED, AND READY TO FIRE by the single action trigger pull mode.

Always keep finger off the trigger until ready to fire. Make sure the muzzle is pointing in a safe direction.

IF NOT READY TO FIRE activate the hammer-decocking lever by a firm downward thumb pressure rotation to solid stop. This hammer-decocking lever rotation will separate the firing pin unit from the hammer path as the hammer is automatically lowered to rest against the slide breach at the last stage of rotation, simultaneously compressing the decocking lever return springs. When removing the thumb, the lever will automatically by energetic spring action return to its deactivated position pronounced by the wings pointing straight forward and vivid Red Warning Dots. The firing pin unit is realigned in front of the hammer.

CAUTION: The pistol is now **CHAMBER LOADED, HAMMER DECOCKED** **READY TO FIRE** by the double action trigger pull mode. Keep finger off trigger.

LOADING TO MAXIMUM PISTOL CAPACITY: During normal chamber loading, as described above, the pistol contains one round in the chamber plus 14 rounds in the magazine. This is an advantage because the magazine spring is not fully compressed but under about the same tension as a 15-round loaded spare magazine.

- If the shooter after normal chamber loading from a 15-round loaded magazine prefers to load the pistol to its full 16-round capacity, take the following steps.
 1. Remove the magazine by depressing the magazine release button.
 2. Replenish the magazine with one round only to its full 15-round capacity.
 3. Push the magazine into the pistol grip insuring catch engagement.
- If the shooter, during firing, exchanges magazines before the pistol is fired empty and the exchanged magazine is fully loaded, the pistol will contain its maximum 16-round capacity.

DIRECT CHAMBER LOADING:

The major advantages of the pistol's open slide and extractor configurations are the remote chances of feeding, extraction and/or ejection malfunctions. In the rare event of feeding and/or extraction jamming the design allows for simplicity and speed in clearing to continue firing. Further, the unique design principle makes it possible to fire the pistol single shot with ease of operation should the magazine be damaged. Also, it makes it possible to close the slide over a cartridge directly inserted into the chamber:

- With the magazine removed, manually retract the slide and engage the slide catch.
- With the muzzle pointing downward, directly and fully seat a cartridge in the chamber.
- Release the slide to closing.
- By the hammer decocking lever fully lower the hammer.

NOTE: The pistol is now chamber loaded, hammer decocked, ready for discharge by the double action trigger pull mode.

By inserting a fully loaded magazine the pistol will be loaded to its 16-round capacity.

It is possible to direct chamber load with an empty magazine inserted.

If shooting single shot without a magazine, the slide will remain closed over the empty chamber after discharge.

If shooting single shot with empty magazine inserted, the slide will stay open after discharge.

FIRING:

WHEN READY TO FIRE:

- Aim the pistol and align front and rear sight on target.
- Fire by squeezing the trigger.
- In the double action trigger pull mode the hammer will be cocked and released to fall.
- The discharge pressure will recoil the locked barrel/slide unit, compressing the recoil spring, disengaging the locking system, extract and eject the spent cartridge case and cock the hammer. The recoil spring will push the slide forward chambering the next cartridge from the magazine and re-engage the locking system. After trigger finger ease-up, permitting the trigger to move forward to its single action mode position, the **PISTOL IS READY TO FIRE AGAIN.**

- Squeeze the trigger to continue firing. After the first shot is fired all remaining rounds in the magazine will be fired in the single action mode.
- When the last round has been fired, the slide is automatically held open by the slide catch (Fig. 11).
- To fire again, remove the empty magazine and insert a loaded one.
- Press the slide catch (Fig. 1-F1) to load the chamber and close the slide (Fig. 12).
- The slide can also be closed for chamber loading by simply retracting and releasing the slide.

CAUTION: THE PISTOL IS NOW LOADED, COCKED, AND READY TO FIRE.

FIRING AFTER MANUAL HAMMER COCKING:

If the hammer is fully-lowered, and you prefer to fire the first shot by the single action mode, make sure your trigger finger is out of the trigger guard and then manually retract the hammer to its fully-cocked position. **WHEN READY TO FIRE,** squeeze the trigger.

UNLOADING THE PISTOL:

CAUTION: The pistol can be unloaded with the hammer cocked. For optimum degree of safety it is recommended to proceed with the hammer decocked. **KEEP FINGER OFF TRIGGER.**

- Firmly depress and release the hammer decocking lever, insuring the hammer is lowered to solid rest against the slide breech.
- Depress the magazine release button as to remove the magazine from the pistol.

- Grasping the slide serration with thumb and index finger, fully retract the slide to extract and eject the chambered cartridge.
- Holding the slide retracted visually inspect through the open slide that the magazine well and chamber are clear. **WHEN SURE THE CHAMBER IS EMPTY AND THE CARTRIDGE HAS BEEN EJECTED, quickly release the slide for closing.**
- Decock the hammer by depressing the hammer decocking lever.

WARNING: To prevent accidents due to wrongful unloading practice - remember:

First: REMOVE MAGAZINE
Second: CLEAR CHAMBER

UNLOADING THE MAGAZINE:

- To unload the magazine with ease, grasp with one hand around the magazine box, bottom down and front end forward. With the tip of the thumb firmly press down on the cartridge rim, to elevate the bullet nose, and push. As the bullet moves over the front wall, tip it slightly upward with the index finger to ease the cartridge over the front wall.
- Repeat until the magazine is unloaded.

MAINTENANCE:

- In an emergency situation a properly maintained pistol loaded with quality ammunition may save your life. Always keep it clean and lightly lubricated.
- Do not use the pistol's excellent capability to function under adverse conditions as a reason to relax normal maintenance procedures.
- Every time the pistol is fired or at least once a month, cleaning and lubrication is recommended. Start with:

FIELD STRIPPING:

CAUTION: Make sure the pistol is unloaded. See paragraph "Unloading the Pistol".

NOTE: The pistol is designed for ease of field stripping under adverse conditions. The photos show the most illustrative method. The text will explain other methods of manipulation. With a little practice field stripping can be performed in seconds.

Use the grasping method most convenient for manipulation control and comfort.

The pistol can be disassembled and assembled with the hammer fully-lowered, half-cocked or fully-cocked. For simplicity and ease of operation keep the hammer decocked.

To avoid parts damage **DONOT PULL THE TRIGGER** while removing and mounting the slide.

- Decock the hammer by depressing the hammer decocking lever.
- Remove magazine by depressing magazine release button.

- Hold pistol in the right hand, muzzle slightly elevated; with the left forefinger depress the disassembling latch release button and with the left thumb rotate the disassembling latch clockwise until its stops, wing pointing down (Fig. 13).

NOTE: The disassembling latch can be reached and depressed by the right hand index finger while using the left thumb to either pull or push down the latch wing.

When using the left hand to operate the disassembling latch system you can choose to place your left hand from below the frame pulling down the latch wing or place your left hand above the slide pushing down the latch wing by the thumb.

- In one smooth stroke pull the barrel/slide assembly forward off the frame (Fig. 14).

WARNING: The recoil spring guide is held under pressure by the recoil spring. Be careful not to inadvertently cause this unit to "shoot off" the barrel/slide assembly.

NOTE: The barrel/slide assembly can be pulled off the frame also by grasping the slide from above. That method has the advantage that the thumb can be swung under the slide, supporting the recoil spring/guide unit while pulling the barrel/slide assembly off the frame.

- To dismantle the recoil spring guide unit, rest the barrel/slide assembly turned upside down in the palm of your hand, muzzle forward (Fig. 15).

CAUTION: Spring and guide are under tension.

- Place the tip of the index finger at the front corner of the slide and the tip of the thumb on the head of the recoil spring guide and squeeze, just enough to obtain the spring pressure. Carefully swing up the recoil spring guide until its head clears the locking block and barrel lug. Ease up thumb pressure to relax spring tension and remove spring and guide.

NOTE: The recoil spring guide can also be dismantled by:

Grasping the head of the guide between thumb and index finger, push forward, lift and ease up spring tension.

By placing the thumb across the locking block, push forward, lift and ease up spring tension.

- To dismantle the barrel/locking block unit from the slide, proceed as follows: Keeping the slide in the palm of your hand as when removing the recoil spring and guide (Fig. 16), place the tip of the index finger in front of the front barrel lug and the thumb against the plunger protruding the rear barrel lug. Push the plunger forward to raise the locking block. When the locking block lugs clear the slide's locking block shoulders, push the barrel forward just enough for the barrel to clear the extractor head, lift the barrel to clear the breech and pull it out of the slide.

NOTE: If preferred, support the slide in the palm of your hand, muzzle toward yourself. Place the tip of the index finger on the plunger and the thumb against the barrel front lug (Fig. 17 and 18), otherwise proceed as explained above.

WARNING: Avoid pulling the trigger to initiate hammer fall when the pistol is field stripped.

NO FURTHER DISASSEMBLY IS RECOMMENDED UNLESS DONE BY A COMPETENT GUNSMITH OR ARMORER.

RECOMMENDED SAFETY FEATURE INSPECTION:

To insure the highest degree of functional integrity and self-protection readiness, it is recommended that the pistol be submitted to a periodical cleaning and safety feature, etc. inspection by a competent gunsmith or armorer. This is particularly important when the pistol has been exposed to excessive shooting, adverse field condition usage, dropped against hard surface, sand, mud or into salt water.

WHAT TO USE FOR CLEANING:

For normal barrel cleaning purpose use a standard barrel brush and if necessary to brush out stubborn gunpowder residue and/or metal deposit, use a metal bore brush and standard flannel patches.

For general action cleaning use lint free cloth, a small brush, pipe cleaners, cotton swabs, toothpicks and a small wood applicator to remove stubborn dirt, etc. **DO NOT** use sharp instrument.

Use a good grade of CLP (cleaning-lubricant-preservative) gun oil.

Most guns and sporting goods stores can supply suitable cleaning kits.

BARREL CLEANING AND LUBRICATION:

Wet the brush with CLP gun oil. Insert the brush into the barrel from the chamber and scrub chamber and bore thoroughly.

Dry chamber and bore by pushing a tightly fitting flannel patch through the chamber and bore with the brush or cleaning rod. Keep changing patch until it emerges clean.

Clean the locking block with a cloth soaked in CLP gun oil; if necessary use a brush. Wipe clean.

Lightly oil chamber and bore by passing a clean CLP gun oil moistened flannel patch through from the chamber. Lightly oil exterior of barrel and locking block, making sure the rails are lubricated. Lightly oil the locking block, making sure its front and rear hinge surfaces are lubricated. Place a drop of oil around the locking block plunger. Check and make sure the locking block and plunger move freely.

NOTE: When cleaning barrel after shooting be sure to recheck the chamber and bore for possible gunpowder residue sweat-out a few days after the shooting/cleaning.

SLIDE CLEANING AND LUBRICATION:

Clean slide with cloth and/or brush soaked in CLP gun oil, paying special attention to the breech face and extractor, slide rails, underside of breech and the back surface around firing pin plunger, hammer decocking lever, etc. Wipe clean.

Lightly oil the slide. Place a few drops of oil on the slide rails and smooth it out throughout the length of the rails, likewise oil underside of breech. With the thumb push the extractor outward, drop a few drops of oil alongside the extractor and move it briskly to insure internal penetration. From below place a drop of oil around the firing pin catch and push and release to insure free movement and oil penetration. Place a few drops of oil to each side of the hammer-decocking lever and to its crossbolt and firing pin unit from the rear of the breech, move lever repeatedly to insure oil penetration and free movement. Wipe off excessive lubrication.

- To check the functional relationship between firing pin unit and firing pin catch and to insure internal cleaning/lubrication, push with a punch (ballpoint pen) the firing pin unit forward to solid stop. The tip of the firing pin must not protrude breech face.
- With the tip of the finger, from below the slide breech, push the firing pin catch fully up and hold it while pushing the firing pin unit forward. The firing pin tip must protrude the breech face and move freely back and forth under energetic spring force.

RECOIL SPRING AND GUIDE LUBRICATION:

Wipe or brush clean the spring and guide. Lightly oil the guide rod. Wipe the spring clean only with an oily cloth.

FRAME CLEANING AND LUBRICATION:

With a CLP gun oil soaked cloth or bristle brush, thoroughly clean all areas covered with gunpowder residue and field dirt. Brush out the magazine well using the bristle bore brush only. In hard to reach areas use pipe cleaners or cotton swabs.

Wipe clean and lightly lubricate rails and moving parts. With a few drops of oil and parts movement to insure oil penetration, particularly lubricate the disassembling latch, magazine catch release button, slide stop, trigger system, hammer, sear, and the levers in front of the hammer.

NOTE: For ease of pistol assembly make sure the hammer is fully-lowered and the disassembling latch in take-down position, its wing pointing straight down.

MAGAZINE CLEANING AND CARTRIDGE ROTATION:

Be sure to thoroughly clean the magazine(s). After cleaning, wipe with a lightly oil moistened cloth.

NOTE: If the pistol is carried chamber and/or magazine loaded, it is important to avoid that the chamber round (due to repeated loading and unloading) and the top five cartridges in the magazine (due to vibrational striking against the magazine taper guide ribs) are slightly indented, that the chambered round together with rounds in the magazine(s) be periodically inspected and position rotated during the after cleaning reloading.

This to insure that particular cartridges do not get damaged to such an extent that they may cause malfunctioning.

AFTER FIELD STRIPPING ASSEMBLY:

Assemble by following the Field Stripping procedure in reverse order. It is advisable to pay attention to the following points:

- The barrel should rest perfectly flush against the slide (the extractor must lodge in its barrel groove).
- The locking block lugs must be in the slide's locking lug shoulder slot (the locking block plunger must protrude from the rear barrel lug).
- The recoil spring and guide must be parallel to the barrel and slide side walls and particularly important, the head of the recoil spring guide perfectly seated into its half round cutout in the locking block. Thumb pressure on the head will insure perfect sealing.

NOTE: If the recoil spring plunger head is not properly seated the slide cannot be pushed back on the frame to engage the disassembling latch.

- Before barrel/slide unit mounting to the frame insure that the disassembling latch is in its disassembly position (wing pointing straight down) and the hammer fully-lowered.

After assembly and before loading insure by manipulation that the slide reciprocates freely, the hammer-decocking lever, trigger system, slide stop, and magazine catch release button function perfectly. Check all magazines in the pistol.

AMMUNITION:

Using good quality ammunition combined with preventive maintenance will make the pistol perform lawlessly through years of service. To prevent malfunctioning always visually inspect each cartridge for external damage before loading.

The pistol is designed and proof tested to withstand continued shooting with all brands and types of commercial ammunition manufactured to standard S.A.A.M.I. specifications known as:

9mm Parabellum, 9mm Luger, 9x19mm

We do not recommend extended use of +P+ or submachine gun ammunition because the chamber pressure may reach or exceed proof load pressure, decreasing the major components service life expectancy.

The warranty does not cover the use of reloaded and/or hand loaded ammunition.

WARNING: If using reloaded cartridges containing solid lead bullets, take the following precautions:

DONOT use any ammunition on which the case mouth is CRIMPED into the bullet.

Make sure the bullets are of the right caliber size according to S.A.A.M.I. specifications.

Avoid the use of bullets having sharp contour step close to case mouth.

Lead bullets have a tendency to cause bore leading which may dramatically increase the discharge pressure.

Make sure to remove all chamber and bore lead accumulation after each shooting.

DONOT ever shoot cartridges with jacketed bullets through a barrel previously fired with lead bullets before the bore is thoroughly cleaned.

Repeated reloading will structurally weaken the case head/web section which may result in case rupture.

DRY FIRING/"DUMMY" ROUNDS:

If you want to practice aim and trigger pull, insert a **FIRE**d cartridge case or "DUMMY" cartridge in the chamber to cushion the fall of the firing pin and eliminate the chance of firing pin breakage.

Hammer fall in connection with the normal use of the manual hammer-decocking lever **DOES NOT** cause firing pin breakage.

Your dealer can supply different "DUMMY" cartridges.

NOTE: "DUMMY" cartridges with spring loaded "Primer" are excellent but expensive.

"DUMMY" cartridges with solid head are good for loading/unloading and dry firing practice.

"DUMMY" cartridges with empty primer pockets are good for loading/unloading practice but DOES NOT protect the firing pin when dry firing.

TROUBLE SHOOTING, CAUSE AND REMEDIES

<u>FAILURE</u>	<u>CAUSE</u>	<u>ACTION</u>
Failure to feed	1 Defective cartridge, bent, indented, burred, etc.	Replace
	2 Dirty chamber and/or action	Clean, lubricate
	3 Dirty magazine	Clean
	4 Damaged, indented burred magazine lips, etc.	Replace, repair by armorer
Misfire/Hangfire	1 CAUTION: A misfire could be a hangfire-delayed discharge. Keep hands away from slide in case of recoil.	Fire double action, wait 10 seconds before reloading.
	2 Hammer-decocking lever not turned to its full "OFF" position.	Turn lever and fire double action
	3 Dirt prevents free and complete slide closing, hammer fall and/or firing pin strike.	Clean and lubricate
	4 Extractor jammed by powder residue or field dirt	Wash out in cleaning solution and lubricate
Failure to extract	1 Extractor jammed by powder residue or field dirt	Wash out in cleaning solution and lubricate
	2 Chamber dirty	Clean, lightly lubricate
	3 Defective cartridge	Replace
	4 Short recoil, defective cartridge, bullet may be lodged in bore	Inspect barrel bore
Failure to eject	1 Damaged ejector	Service by armorer
	2 Short recoil, defective cartridge, bullet may be lodged in bore	Inspect barrel bore

NOTE: When repair is needed contact our Service Department or a competent gunsmith or armorer.

TECHNICAL SPECIFICATIONS:

Caliber/Ammunition	9mm Parabellum, 9mm Luger, 9mm NATO or 9x19mm
System of operation	Semiautomatic, short stroke, delayed blowback recoil operated
Locking system	Straight barrel/slide unit reciprocation with oscillating locking block
Hammer	Exposed, with cocking spur and drop-catch feature
Trigger	Double/single action
Hammer-decocking lever	Slide mounted manual ambidextrous hammer-decocking lever with "OFF" position marked by vivid red warning dot

Firing pin catch	Automatically engaged catch prevents accidental discharge by firing pin inertia. Deactivated only at the moment of trigger pull hammer fall.
Slide catch	Automatically secures the slide open when recoiled or manually retracted over empty magazine
Grips	Black plastic or walnut
Rifling	6 grooves right hand, pitch 250mm (about 1 turn in 10 in.)
Front sight	Square post integral with slide, white dot
Rear sight	Square notched bar, dovetailed to slide, with white post or 3-dot.
(Note: Optional Trijicon 3-Dot Night Sights)	
Barrel length	125mm (4.92 in.)
Sight radius	158mm (6.22 in.)
Overall length	217mm (8.54 in.)
Overall height	140mm (5.51 in.)
Overall width	38mm (1.50 in.)
Weight of pistol w/empty magazine)	960g. approx. (33.86 oz.)
Weight of Magazine (empty)	107g. (3.82 oz.)
Weight of loaded pistol (115 gr. NATO BALL)	1145g. approx. (40.89 oz.)
Weight of loaded magazine	292g. (10.42 oz.)

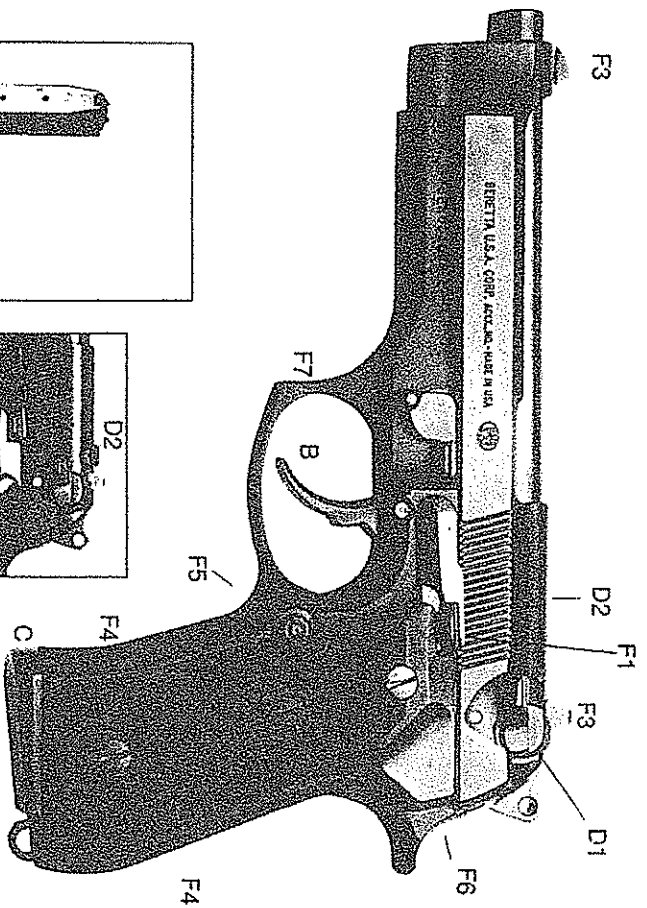

Fig. 1

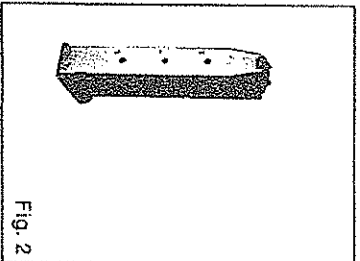

Fig. 2

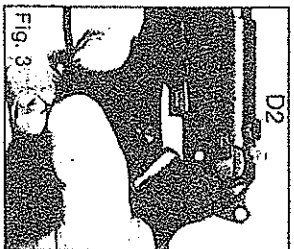

Fig. 3

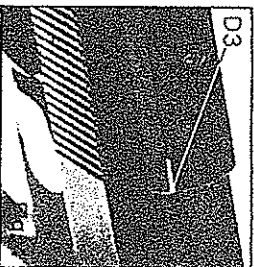

Fig. 4

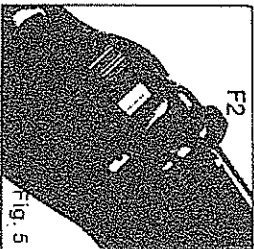

Fig. 5

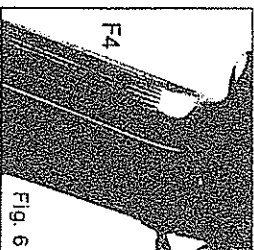

Fig. 6

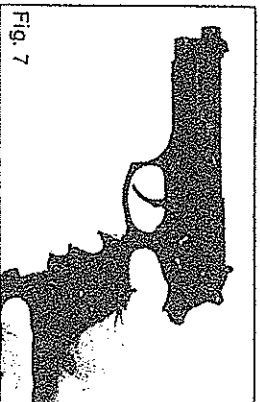

Fig. 7

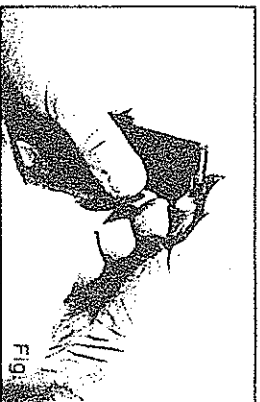
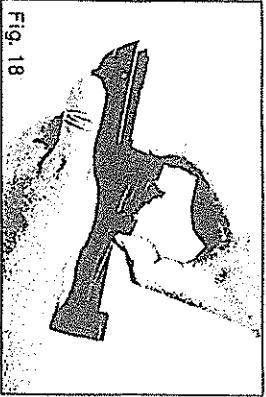
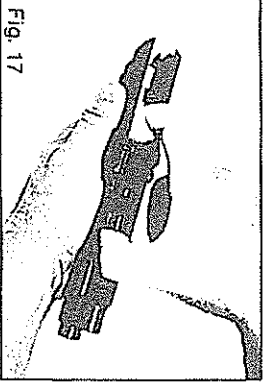
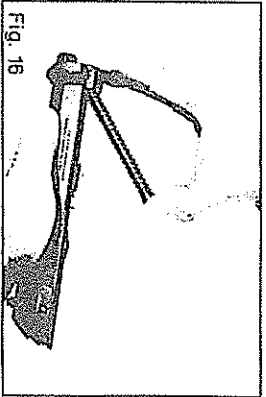
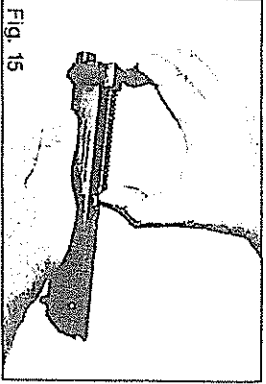
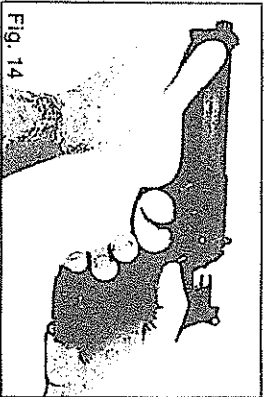
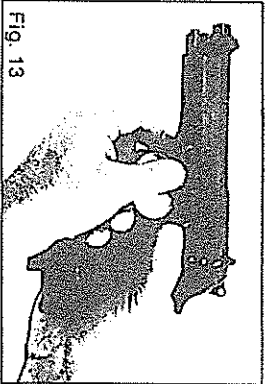
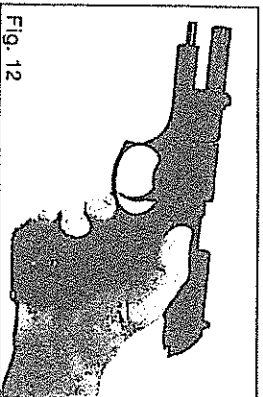
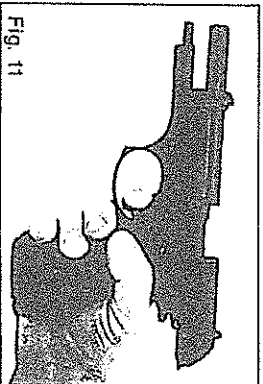
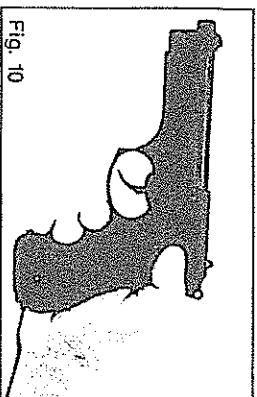
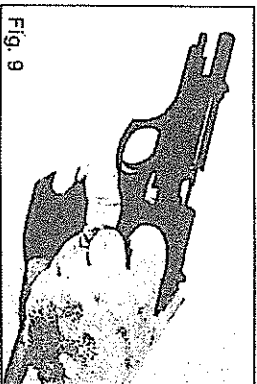
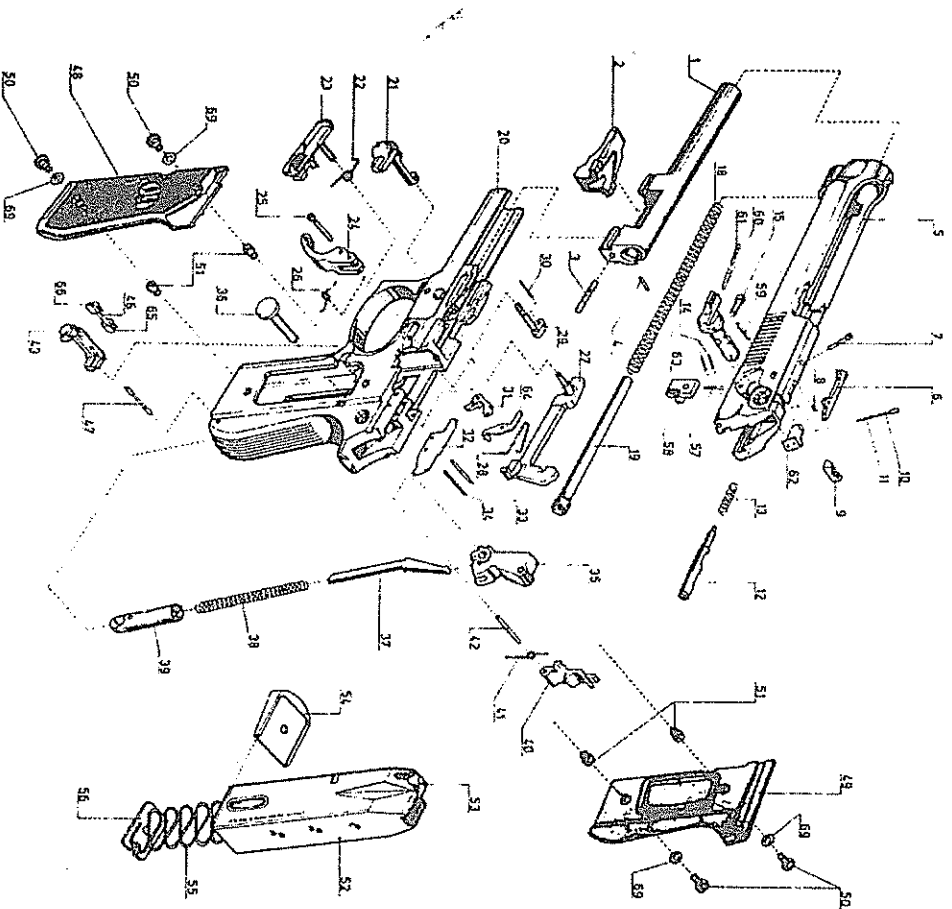

Fig. 8



EXPLODED DRAWING



NOTE: Exploded drawing is provided to aid the user in understanding the pistol's functioning only and in aiding the gunsmith or armorer in ordering parts when needed for repair.



BERETTA USA CORP

Parts List — MODEL 92G

Part # Nomenclature		Part # Nomenclature	
1	Barrel (Factory Fitting Required)	35	Hammer
2	Locking Block	36	Hammer Pin
3	Locking Block Plunger	37	Hammer Spring Guide
4	Locking Block Plunger - Retaining Pin	38	Hammer Spring
5G	Slide (Factory Fitting Required)	39	Hammer Spring Cap
6	Extractor	40	Sear
7	Extractor Pin	41	Sear Spring
8	Extractor Spring	42	Sear Pin
9	Rear Sight (Fitting Required)	43	Magazine Release Button
9	Rear Sight (Fitting Required)	46	Magazine Release Button Spring
10G	Right Decocking Plunger	47	Hammer Spring Cap Spring Pin
11G	Right Decocking Spring	48	Grips (Plastic) Pair
12	Firing Pin	48&49P	Grips (Plastic) Pair
13	Firing Pin Spring	48&49W	Grips (Wood) Pair
14G	Hammer Decocking Lever	50	Grip Screw
15	Firing Pin Plunger	51	Grip Brush
18	Recoil Spring	52	Magazine Box *
19	Recoil Spring Guide	53	Magazine Follower
20	Firara	54	Magazine Bottom
21	Disassembling Latch	55	Magazine Spring
22	Slide Catch Spring	56	Magazine Lock Plate
23	Slide Catch	57	Firing Pin Catch Spring
24	Trigger	58	Firing Pin Catch
25	Trigger Pin	59	Firing Pin Catch Retaining Spring Pin
26	Trigger Spring	60	Left Decocking Spring
27	Trigger Bar	61	Left Decocking Plunger
28	Trigger Bar Spring	62G	Right Decocking Lever
29	Disassembling Latch Release Button	63	Right Decocking Lever Spring Pin
30	Disassembling Latch Release Button Spring	64	Firing Pin Catch Lever
31	Hammer Release Lever	65	Magazine Catch Spring Bush (Short)
32	Ejector	66	Magazine Catch Spring Bush (Long)
33	Hammer Release Lever Pin	69	Spring Washer
34	Ejector Spring Pin		

* Sold only as complete magazine

NOTE: Always specify Model 92G when ordering parts.

PARTS AND SERVICE:

In-warranty as well as general repair and maintenance service is available from our Product Service Dept.

In most instances your local dealer can assist with answers relating to maintenance and parts.

Parts price list and parts can be ordered from our Product Service Department.

Please read the WARRANTY - it gives valuable information concerning in-warranty service, or write to:

BERETTA U.S.A. CORP.
Customer Service Dept.
17601 Beretta Drive
Accokeek, MD 20607
Phone: (800) 636-3420 Fax: (301) 283-0308

LIMITED WARRANTY

THIS "LIMITED WARRANTY" HAS BEEN DRAFTED TO COMPLY WITH THE MAGNUSON — MOSS WARRANTY FEDERAL TRADE COMMISSION IMPROVEMENT ACT WHICH IS EFFECTIVE FOR GOODS MANUFACTURED ON OR AFTER DECEMBER 31, 1976.

Beretta U.S.A. Corp. warrants that this firearm was manufactured free of defects in material or workmanship; and for a period of one (1) year after date of purchase, the Manufacturer agrees to correct by repair or replacement (with same or comparable quality model) your firearm, without charge, if returned prepaid.

THIS WARRANTY IS VOID IF THE FIREARM HAS BEEN ABUSED, MISUSED, DAMAGED BY ACCIDENT, FIRED WITH HAND LOADED AND/OR RELOADED OR IMPROPER AMMUNITION OR OBSTRUCTION IN THE BARREL, OR DAMAGED BY FAILURE TO PROVIDE REASONABLE AND NECESSARY MAINTENANCE. THIS WARRANTY DOES NOT APPLY TO NORMAL WEAR OF ANY PARTS, INCLUDING METAL, WOOD, PLASTIC, RUBBER AND OTHER MATERIAL'S SURFACE FINISH OR IF UNAUTHORIZED REPAIR AND/OR ALTERATION HAS BEEN PERFORMED.

The terms of the warranty cannot be changed except in writing by an officer of Beretta U.S.A. Corp.

Wholesalers and Dealers (unless a Beretta U.S.A. Corp. Authorized Gunsmith) are not authorized to make any in-warranty repair or adjustment on behalf of Beretta U.S.A. Corp.

This warranty gives only the original retail purchaser specific legal rights; other rights may also be available which may vary from state to state.

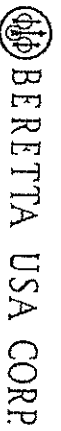

17601 BERETTA DRIVE • ACCOKEEK, MARYLAND 20607

Phone: (301) 283-2191

Fax: (301) 283-0435